



Airwork's angular pneumatic grippers are the right solution for simple manipulation applications while maintaining a very compact design to reduce as much as possible their overall dimensions. Thanks to the possibility to assemble them in different positions, they can be used for several applications. Moreover, there's the possibility to insert a round magnetic switch in each of the four side surfaces.

Les pinces pneumatiques angulaires d'Airwork, sont la solution idéale pour des applications de manipulation simples, avec un design très compact pour garder leurs petites dimensions.

Grâce à la possibilité de les assembler dans différentes positions, ils peuvent être utilisés pour plusieurs applications.

De plus, il y a la possibilité d'insérer un capteur magnétique rond dans chacune des quatre surfaces latérales.

Le pinze pneumatiche ad apertura angolare di Airwork rappresentano la soluzione giusta per applicazioni di manipolazione semplice ma con la necessità di ridurre al massimo gli ingombri. Grazie alla possibilità di montaggio in diverse posizioni, rispondono alle esigenze di impiego più svariate. Inoltre è possibile inserire il sensore magnetico tondo su tutte le facciate della pinza.

ORDERING CODE / CODIFICATION / CHIAVE DI CODIFICA

PA300

Ø gripper / Ø pince / Ø pinza
10 - 16 - 20 - 25 mm

VERSION / VERSION / VERSIONE

3= double acting / **double effet** / doppio effetto

5= single acting rear spring / **simple effet ressort arrière** / semplice effetto molla posteriore

TECHNICAL DATA / DONNÉES TECHNIQUES / DATI TECNICI

Fluid / Fluide / Fluido	Lubricated or non lubricated air / Air lubrifié ou non lubrifié / Aria con o senza lubrificazione
Operating temperature range / Température d'utilisation / Temp. di esercizio	-10C° / +80C°
Pressure range / Pression d'utilisation / Pressione di utilizzo	2 - 7 bar
Action tolerance / Tolérance d'action / Tolleranza d'azione	± 0.1mm
Max operating frequency / Fréquence de fonctionnement max. / Max frequenza operativa	180 c.p.m.

COMPONENTS / COMPOSANTS / COMPONENTI

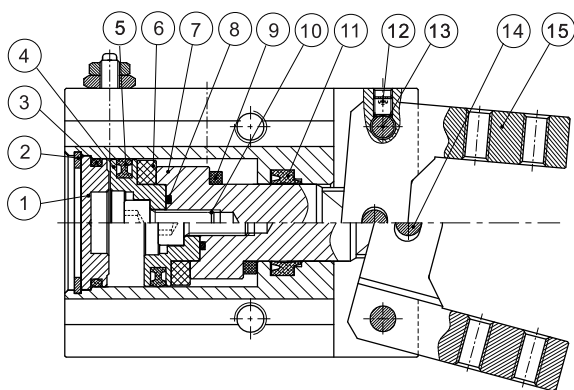

pos.	description / description / descrizione	material / matériel / materiale
1	rear cap / fond postérieur / testata post.	aluminium / aluminium / alluminio
2	snap ring / anneau élastique / seeger	steel alloy / Alliage d'acier / acciaio
3	O-ring / joint torique / O ring	NBR
4	piston / piston / pistone	aluminium / aluminium / alluminio
5	seal piston / joint piston / guarnizione pist.	NBR
6	magnet / aimant / magnete	synthetic rubber / caoutchouc / gomma sintetica
7	piston rod / tige / stelo	aluminium / aluminium / alluminio
8	O-ring / joint torique / O ring	NBR
9	bumper / pare-chocs / para colpi	PTEE
10	screw / vis / vite	steel alloy / Alliage d'acier / acciaio
11	seal / joint / guarnizione	NBR
12	screw / vis / vite	steel alloy / Alliage d'acier / acciaio
13	pin / épingler / perno	stainless steel / acier inox / acciaio inox
14	pin / épingler / perno	stainless steel / acier inox / acciaio inox
15	finger / doigt / dito	steel alloy / Alliage d'acier / acciaio

Effective holding force
Force de préhension effective
Forza di presa

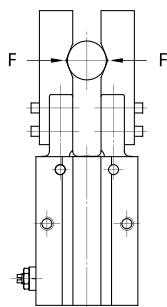

Holding point
Point de préhension
Punto di presa

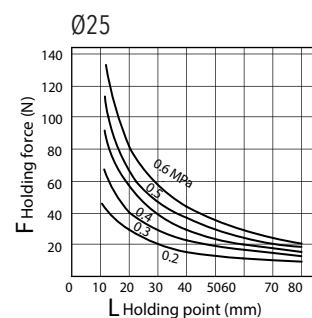
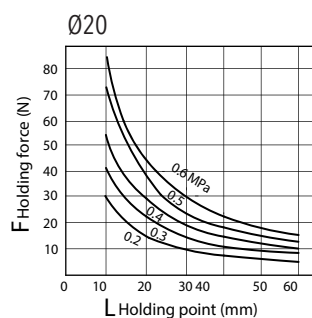
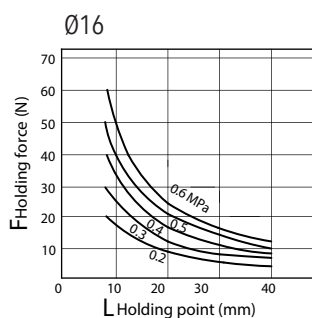
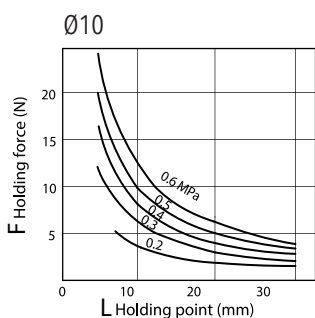
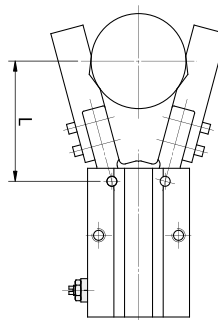

Installation / **Installation** / *Installazione*

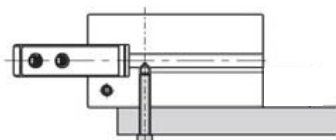

	Bolt Size Taille de vis Dimensione vite	Max. Locking Torque Max. Couple de verrouillage Max. Coppia di bloccaggio
Ø10	M3x0.5	0.69 Nm
Ø16	M4x0.7	2.1 Nm
Ø20	M5x0.8	4.3 Nm
Ø25	M6x1.0	7.3 Nm

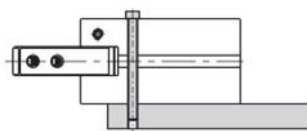

	Bolt Size Taille de vis Dimensione vite	Max. Locking Torque Max. Couple de verrouillage Max. Coppia di bloccaggio
Ø10	M2.5x0.45	0.49 Nm
Ø16	M3x0.5	0.88 Nm
Ø20	M4x0.7	2.1 Nm
Ø25	M5x0.8	4.3 Nm

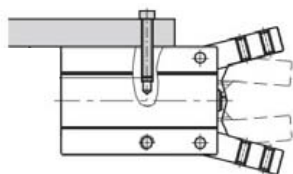

	Bolt Size Taille de vis Dimensione vite	Max. Locking Torque Max. Couple de verrouillage Max. Coppia di bloccaggio
Ø10	M3x0.5	0.88 Nm
Ø16	M4x0.7	1.6 Nm
Ø20	M5x0.8	3.3 Nm
Ø25	M6x1.0	5.9 Nm

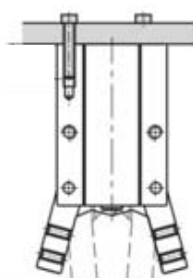

	Bolt Size Taille de vis Dimensione vite	Max. Locking Torque Max. Couple de verrouillage Max. Coppia di bloccaggio
Ø10	M3x0.5	0.88 Nm
Ø16	M4x0.7	2.1 Nm
Ø20	M5x0.8	4.3 Nm
Ø25	M6x1.0	7.3 Nm

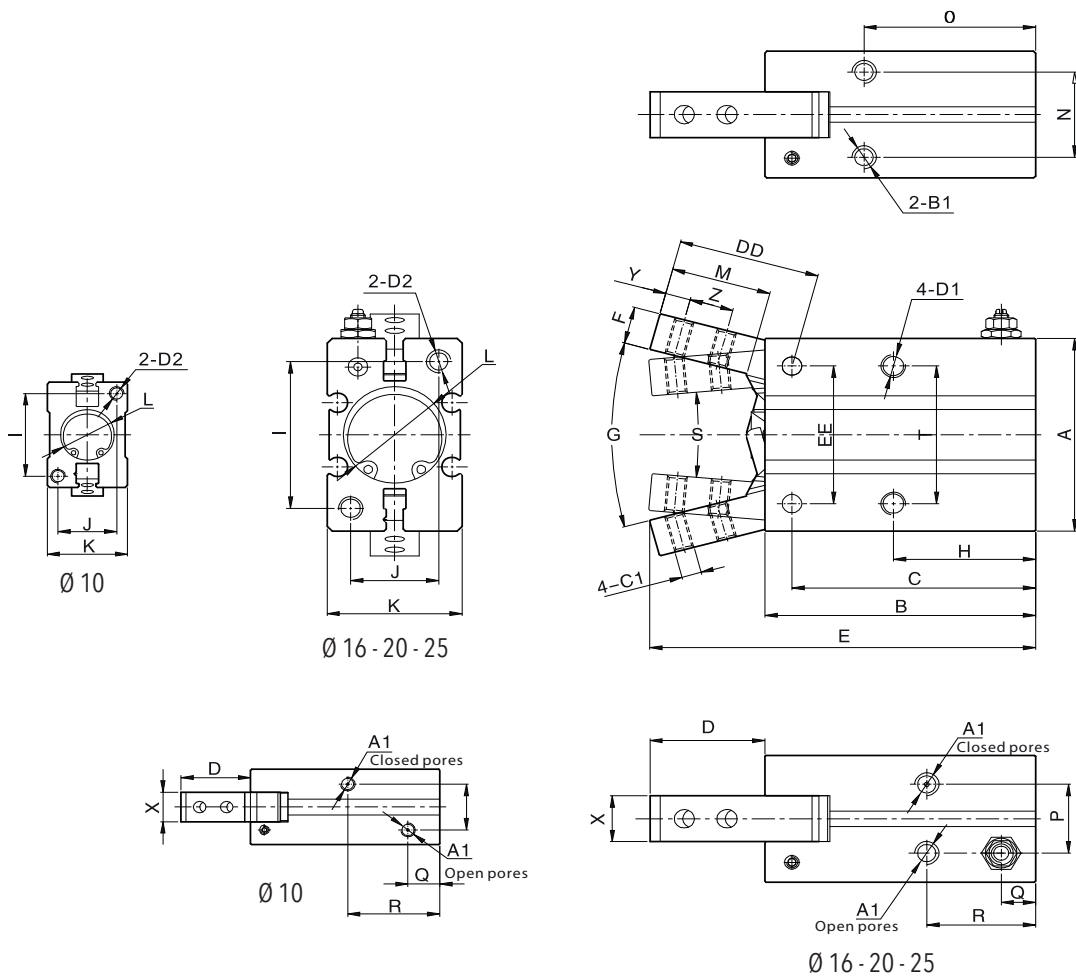

Ø	A	A1	B	B1	C	C1	D	DD	D1	D2	E	EE	F	G	H	I	J
10	23	M3x0.5	38.6	M3x0.5 depth 6	35.8	M2x0.45	14.2	17.2	M3x0.5 depth 6	M3x0.5 depth 6	52.8	14	4	30°	23	18	12
16	30.6	M5x0.8	44.6	M4x0.7 depth 5.5	39.7	M3x0.5	18.9	23.6	M4x0.7 depth 9.5	M4x0.7 depth 8	63.5	24	7	30°	24.5	22	15
20	42	M5x0.8	55.2	M5x0.8 depth 8	49.7	M4x0.7	23.5	29	M5x0.8 depth 11.5	M5x0.8 depth 10	78.7	30	8	30°	29	32	18
25	52	M5x0.8	60.4	M6x1.0 depth 10	54.8	M5x0.8	32.8	38.5	M6x1.0 depth 14.5	M6x1.0 depth 12	93.2	36	10	30°	30	40	22

Ø	K	L	M	N	O	P	Q	R	S	T	X	Y	Z
10	16.4	Ø11 depth 1.5	12.5	11.4	27	10	6.5	18.8	10°	16	6.4	3	5.7
16	23.6	Ø17 depth 1.5	16.5	16	30	13	6.5	18.3	10°	24	8	4	7
20	27.6	Ø21 depth 1.5	20.5	18.6	35	15	7	22.2	10°	30	10	5.2	9
25	33.6	Ø26 depth 1.5	27.5	22	36.5	19.5	7.4	23.5	10°	36	12	8	12

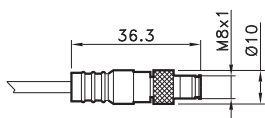
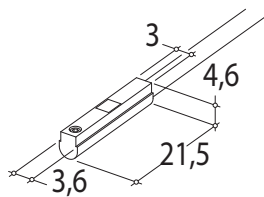

4= black / **noire** / nero
1= brown / **brun** / marrone
3= blue / **bleu** / azzurro



ROUND SWITCH / **CAPTEUR ROUND** / *SENSORE TONDO*

CODE

AR4018010	REED (MT.2,5) / REED (MT.2,5) / REED (MT.2,5)
AR4018020	HALL (MT.2,5) / HALL (MT.2,5) / HALL (MT.2,5)
AR4018110	REED + M8 (CM 30) / REED + M8 / REED + M8 (CM 30)
AR4018120	HALL + M8 (CM 30) / HALL + M8 / HALL + M8 (CM 30)

For technical data see page 1.58

Pour les données techniques, voir page 1.58

Per i dati tecnici vedere pag. 1.58