

La serie di valvole a pedale, vengono proposte con: protezione o senza protezione, con fermo di sicurezza o senza e nelle funzioni 3/2 e 5/2. L'ampia base d'appoggio, garantisce stabilità durante l'utilizzo.

The pedal valves are available with protection or without protection, with or without lock. Available functions are 3/2 and 5/2. The large base ensures stability during the use.

DATI TECNICI / TECHNICAL DATA

Fluido / Fluid	Aria con o senza lubrificazione / Lubricated or non lubricated air
Temperatura di esercizio / Operating temperature range	Max +60C°
Pressione massima di esercizio / Max operating pressure	10 bar
Diametro nominale / Nominal orifice	1/4: 7,5mm

COMPONENTI / COMPONENTS

Protezione / Protection cover	Plastica / Plastic
Corpo / Body	Alluminio / Aluminium
Spola / Spool	Alluminio nichelato / Nickel plated aluminium
Guarnizioni / Seals	NBR
Molla / Spring	Inox / Steel

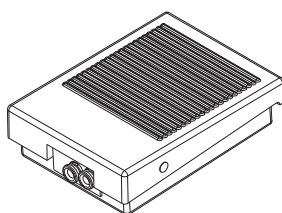
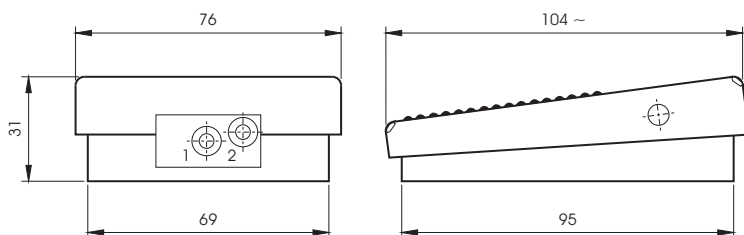

VALVOLA A PEDALE 3/2 NC TUBO 4
PEDAL VALVE 3/2 NC TUBE D.4

CODE: VP40200301

MONOSTABILE
MONO-STABLE

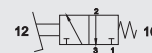

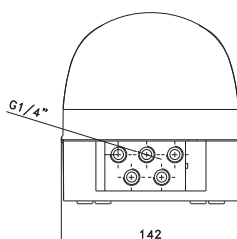
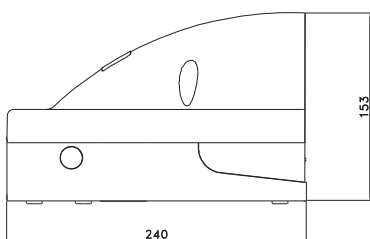

VALVOLA A PEDALE CON PROTEZIONE 1/4 5/2
PEDAL VALVE WITH PROTECTION COVER 1/4 5/2

CODE: VP40010531 MONOSTABILE
MONO-STABLE



CODE: VP40011531 CON FERMO SICUREZZA
WITH SAFETY FEATURE



CODE: VP40010532 BISTABILE
BI-STABLE

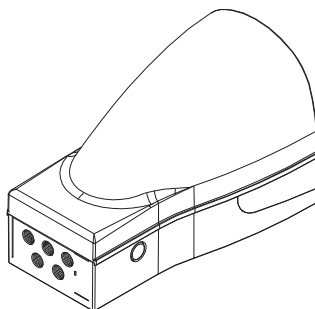
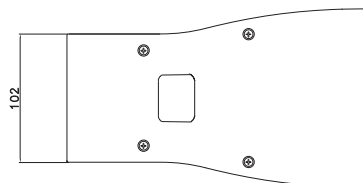
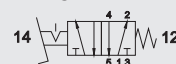

VALVOLA A PEDALE SENZA PROTEZIONE 1/4 5/2
PEDAL VALVE WITHOUT PROTECTION COVER 1/4 5/2

CODE: VP40000531 MONOSTABILE
MONO-STABLE



CODE: VP40000532 BISTABILE
BI-STABLE

